

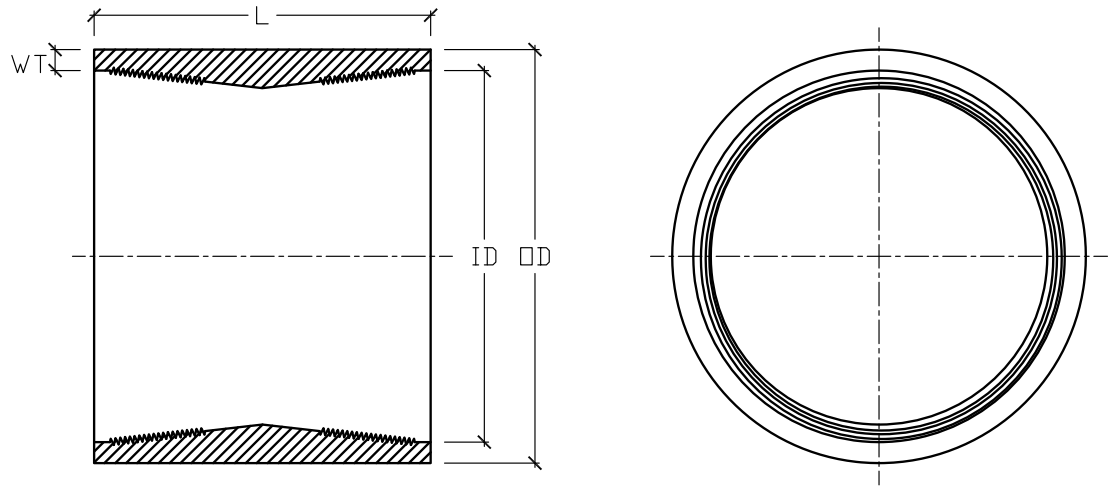

FRP COUPLING
3" DIAMETER
8" LENGTH
150 PSI



NOMINAL INSIDE DIAMETER [ID]	PRESSURE RATING PSI	OUTSIDE DIAMETER [OD]	OVERALL LENGTH [L]	WALL THICKNESS [WT]
3"	150	4"	8"	1/4"

Information appearing in this literature is provided as a guide for the use and application of the products being offered. It is not and does not represent a specific warranty or guarantee of the product or its performance. It is the user's responsibility to determine the suitability of this product for a specific application.

