

FRP STUB FLANGE
14" DIAMETER
50 PSI

NOMINAL INSIDE DIAMETER [ID]	PRESSURE RATING PSI	WALL THICKNESS [WT]	OVERALL LENGTH [L]	OUTSIDE DIAMETER [OD]	BOLT CIRCLE DIAMETER [BC]	FLANGE THICKNESS [FT]	NUMBER OF HOLES [N]	BOLT HOLE DIAMETER [H]
14"	50	3/8"	12"	21-1/2"	18-3/4"	1-1/8"	12	1-1/8"

Information appearing in this literature is provided as a guide for the use and application of the products being offered. It is not and does not represent a specific warranty or guarantee of the product or its performance. It is the user's responsibility to determine the suitability of this product for a specific application.

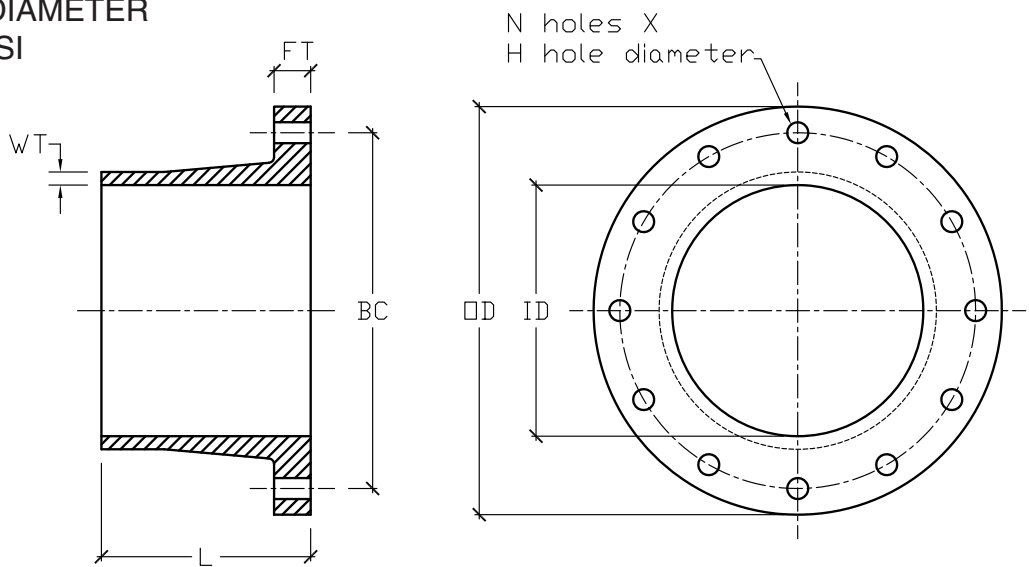